

Power Management solutions

# Enclosure Power Distribution Units



ePDU®



Powering Business Worldwide

# Introduction

Eaton Corporation is a diversified industrial manufacturer with global leadership in the electrical, fluid power, truck, automotive and aerospace industries. Our electrical product series and families—including Powerware®, Cutler-Hammer®, Holec®, MEM®, The Moeller Group, Phoenixtec Power Company Ltd., Santak, MGE Office Protection Systems®, Bill, Elek and Pulizzi—encompass electrical control, power distribution, uninterruptible power systems (UPSs) and industrial automation products and services.

Electrical power is more than just a convenience; it's an essential element of doing business today. To deliver the competitive advantage our customers demand, Eaton helps enterprises proactively measure and manage the power system as a strategic, integrated asset throughout its lifecycle.

Eaton provides the PowerChain Management® solutions your power system needs to operate safely, reliably and efficiently, letting you concentrate on your core business.

From desktops to data centers, our comprehensive power management solutions address the needs of industrial, institutional, government, utility, marine, commercial, residential, IT, mission-critical and OEM markets worldwide. A one-stop partner, Eaton provides UPSs, DC power systems, award-winning power management software and world-class service offerings to render confidence that power problems will not disrupt your systems, data or critical operations.

Eaton solutions have been recognized by end-users and industry experts for delivering the highest customer value and satisfaction, as well as for demonstrating insight into customer needs, among all UPS vendors.\* Our Powerware series solutions are also the global market share leader in medium- and large range UPSs above 5 kVA; they are second-leading in small system UPSs at and below 5 kVA.\*\*

\* Frost & Sullivan Award for 2003 Customer Value and Satisfaction and Frost & Sullivan Award for 2004 Product Line Strategy.  
\*\* Based on Frost & Sullivan 2004 World UPS Markets report data.

## Tradition of technical innovation

From patenting the first AC inverter in 1962 to introducing the unsurpassed Eaton 9395 UPS with 1100 kVA, we have a continuing history of technical innovation. With more than 120 active patents and another 98 patents pending, Eaton maintains a long tradition of using our technical expertise to provide customers with what they need most in a power management solution:

- 2007 Eaton acquires Phoenixtec UPS/PDU in Taiwan
- 2007 Eaton acquires MGE OPS UPS
- 2007 Eaton acquires Pulizzi PDU
- 2007 Eaton acquires Aphel PDU in the UK
- 2007 Eaton introduces a quantum leap in large, three-phase UPS technology, the 9395, which incorporates a modular and upgradable design with internal redundancy for maximum reliability
- 2006 Eaton introduces the high power density and high efficiency BladeUPS rackmount UPS, a 12 kVA modular featuring N+1 parallel redundant systems up to 60 kVA with modular distribution
- 2003 First 6 kVA UPS in 3U for high-density rack applications increases power density by 33%
- 2002 First dual source UPS for rackmount applications
- 2002 Monitoring deployment for over 225,000 data points with Foreseer® proactive enterprise facility monitoring solution
- 2002 First full 100 Mbps switch hub integrated on a network card
- 1996 First UPS with wireless paralleling
- 1993 First UPS to offer load segmentation
- 1989 First high frequency, transformer-free UPS
- 1987 First UPS with advanced pulse-width modulated (PWM) technology and microprocessor-based diagnostics
- 1986 First UPS over 100 kVA for computer rooms
- 1972 First all digitally-controlled UPS
- 1968 First commercial UPS combining battery chargers and inverters
- 1962 First AC power inverter

# Table of Contents

**Overview and Functionalities** ..... 4, 5

**ePDU Units**

- Basic ePDU** ..... 6-9
- Metered ePDU** ..... 10-11
- Monitored ePDU** ..... 12-17
- V55 Series Monitored ePDU** ..... 18
- Advanced Monitored ePDU** ..... 19
- Switched ePDU** ..... 20, 21
- Managed ePDU** ..... 22
- Automatic Transfer Switch ePDU** ..... 23, 24

**Rack Power Module (RPM)** ..... 25

**Environmental Rack Monitor (ERM)** ..... 26

**Enterprise Power Manager (EPM)** ..... 27

**ePDU Plugs and Receptacles** ..... 28

**Power Cables and Accessories** ..... 29

**Mounting Options** ..... 30

**Product Configuration Wizard** ..... 31

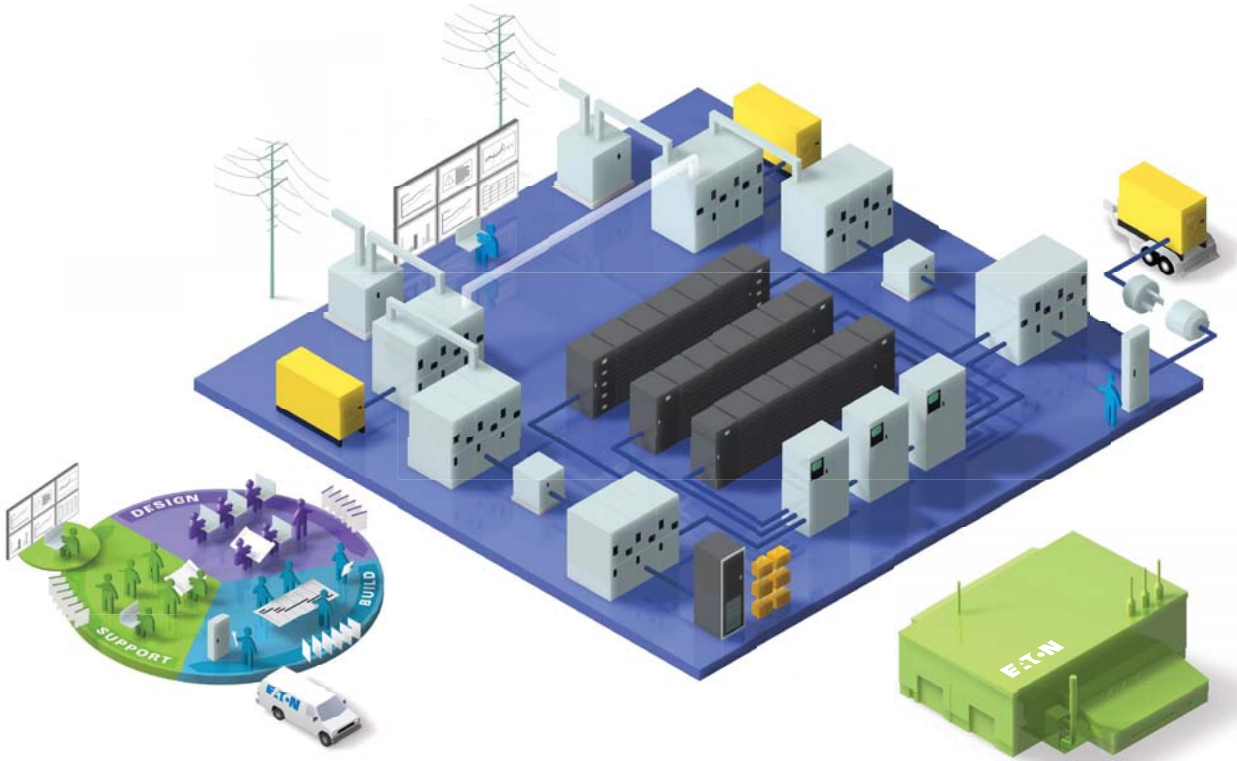

- **Enclosure Power Distribution Units**
- **Intelligent Power™ Distribution**
- **Designed specifically for data center IT environments**
- **Rack mount industrial grade**
- **Provide manageability and customizable enclosure control**
- **Multiple configurations bring forth an impressive array of features and functions**
- **Domestic and international configurations.**
- **Products are designed to meet global safety standards**
- **Certified and Agency approved systems**
- **Mission Critical 24/7/365 reliability**

With today's changing technology and the data centers 99.999% demand for reliability. IT professionals need sophisticated equipment to measure power consumption at the data center level, as well as the server level to understand and control what is happening within their infrastructure. Mission Critical reliability can only be as good as the weakest link in the power chain.

### **Broad Product Portfolio**

Eaton offers the largest selection of enclosure power distribution units available on the market. This complete suite of power products is designed specifically to help data center IT managers meet their rapidly escalating power requirements. Eaton is making the selection of enclosure power distribution units easy with three simple questions:

#### **How much power do you need?**

We have power solutions from 1.44 Kilowatts to 23+ Kilowatts

#### **What functionality do you need?**

We offer a broad range of functionalities including basic, metered, monitored, advanced monitored, switched and managed products

#### **Which inputs and outputs do you need?**

ePDUs are highly configurable, allowing any outlet or plug configuration including single phase, three phase, NEMA and IEC - all on the same ePDU.

### **24/7 Reliability through Circuit Breakers or Individual Outlet Fusing**

ePDUs use individual branch rated circuit breakers that protect load segments (outlet groups), ensuring that an overloaded circuit does not affect other load segments, therefore increasing reliability. Circuit breakers have flat rockers or are fully shrouded to prevent accidental on/off operation. Eaton ePDUs give the option of circuit breaker or individual outlet fusing, giving you options for branch circuit protection or for outlets to be individually protected.

### **High Density Power Solutions**

Do you have power hungry racks of IT equipment, such as blade servers and switches? Are you running out of power capacity before rack space in your enclosure? Everyday higher levels of performance are expected without sacrificing reliability. Eaton offers a full line of high power density solutions to meet your needs. We offer both rackmount and vertical mount three-phase ePDU's ranging from 50 amp, 60 amp and even 80 amp input capacities. These sophisticated units allow an entire rack of equipment to be powered from a single power cord input. Whether you need it cord connected, or hard wired, ePDU has you covered.

### **Rugged Design for Optimal Performance and Quick Installation**

ePDUs are designed to meet global safety standards. These units are engineered with rugged construction, have flexible mounting options, and multiple features ensuring the highest quality and customer satisfaction. Eaton, engineering unique solutions for the most power intense environments.

### **Offering a Broad Range of Enclosure Power Distribution Units**

Eaton's ePDUs provide all power densities and technologies to satisfy the demand of every data center. Offering single to dual chassis, seven technology options, the broadest power range and the ability to manufacture custom ePDUs, allowing arrangement of outlets (number and type) for every region.

ePDUs are distinguished for their quality, dependability and versatility. All products are designed for the specific application with the emphasis on safety and reliability. The line includes an extensive range of vertical Zero U products, that do not occupy server space in racks, as well as 1U and 2U formats. Environmental Monitoring options are also available.

### **Features Overview**

- **Basic (BA)**
- **Metered (ME)**
- **Monitored Network (MI)**
- **Advanced Monitored (AM)**
- **Switched (SW)**
- **Managed (MA)**
- **Automatic Transfer (AT)**

# ePDU® Functionalities



## Basic (BA) pages 6-9

- Reliable and economical enclosure power distribution
- Vertical and horizontal mounting capabilities



## Metered (ME) pages 10-11

- Monitor the amperage passing through each circuit of a ePDU
- Easy-Read LED displays power usage from 12 feet away



## Monitored Network (MI) pages 12-18

- Monitor the amperage passing through each circuit of a ePDU
- Easy-Read LED displays power usage from 12 feet away
- Reading available via Ethernet connection over a network



## Advanced Monitored (AM) page 19

- Monitor the amperage passing through each circuit of a ePDU
- Easy-Read LED displays power usage from 12 feet away
- Reading available via Ethernet connection over a network
- Remote individual outlet level monitoring



## Switched (SW) pages 20, 21

- Individually control outlets via Serial or Ethernet connection
- Voltage Monitoring and Current Monitoring (per group of 8 outlets)
- Local current meter display shows current draw
- External inputs for temperature, humidity, and switch-closure sensors
- Strapping allows control of up to 23 slave units from a master unit



## Managed (MA) page 22

- Includes switched and monitored functionality
- Managing, monitoring and switching of individual outlets
- Includes trending software for in depth analysis



## Automatic Transfer (AT) pages 23, 24

- Provide power redundancy to equipment with 1 or 3 power supplies
- Automatically transfers power from the Primary source to a Secondary source if there is a problem with the primary
- Power is a transferred back to the primary source when it is restored automatically

# Basic ePDU®



## Basic ePDU®

Designed for reliable and cost effective power distribution basic ePDUs have the form factor and receptacle choices to meet the needs of demanding data center architects. With power levels ranging from 1.4kW all the way to 10kW, Eaton has the right ePDU for any application.

### Features:

- High-density, high amperage receptacles support blade servers and network switches
- Satellite units support servers and ancillary equipment
- Clearly labeled circuits simplify load balancing
- Power cord retention bracket improves power connectivity and reliability
- Rotatable rackmount brackets permit side mounting, improving installation flexibility
- High-grade components increases product reliability and fault tolerance
- Soldered or mechanical connections increases product fault tolerance and MTBF



Part Number	Max kW	Input Plug	Function	Cord	Orientation	Receptacles	Dimensions WxHxD	Mounting Option
PW101BA00011	1.44	5-15P	Basic	15'	0U	5-15R (6)	2.1 x 14 x 1.3	B - see page 25



Part Number	Max kW	Input Plug	Function	Cord	Orientation	Receptacles	Dimensions WxHxD	Mounting Option
PW101BA00012	1.44	5-15P	Basic	15'	0U	5-15R (4)	2.1 x 24 x 1.3	B - see page 25



Part Number	Max kW	Input Plug	Function	Cord	Orientation	Receptacles	Dimensions WxHxD	Mounting Option
PW101BA00013	1.44	5-15P	Basic	15'	0U	5-20R (6)	2.1 x 30 x 1.3	B - see page 25

# Basic ePDU®



Part Number	Max kW	Input Plug	Function	Cord	Orientation	Receptacles	Dimensions WxHxD	Mounting Option
PW1018AQU014	1.44	5-15P	Basic	15'	OU	5-20R (8)	2.1 x 48 x 1.3	B - see page 25
PW1018AQU0194	1.44	5-15P	Basic	15'	OU	5-20R (16)	2.1 x 48 x 1.3	B - see page 25
PW1028AQU015	1.92	5-20P	Basic	15'	OU	5-20R (8)	2.1 x 48 x 1.3	B - see page 25



Part Number	Max kW	Input Plug	Function	Cord	Orientation	Receptacles	Dimensions WxHxD	Mounting Option
PW1028AQU016	1.92	5-20P	Basic	15'	OU	5-20R (12)	2.1 x 72 x 1.3	B - see page 25



Part Number	Max kW	Input Plug	Function	Cord	Orientation	Receptacles	Dimensions WxHxD	Mounting Option
PW1028AQU017	1.92	5-20P	Basic	15'	OU	5-20R (8)	2.1 x 16 x 1.3	B - see page 25
PW1028AQU022	1.92	L5-20P	Basic	15'	OU	5-20R (8)	2.1 x 16 x 1.3	B - see page 25



Part Number	Max kW	Input Plug	Function	Cord	Orientation	Receptacles	Dimensions WxHxD	Mounting Option
PW1028AQU018	1.92	L5-20P	Basic	15'	OU	5-20R (12)	2.1 x 60 x 1.3	B - see page 25
PW1028AQU019	1.92	5-20P	Basic	15'	OU	5-20R (12)	2.1 x 60 x 1.3	B - see page 25



Part Number	Max kW	Input Plug	Function	Cord	Orientation	Receptacles	Dimensions WxHxD	Mounting Option
PW1028AQU020	1.92	5-20P	Basic	15'	OU	5-20R (10)	2.1 x 24 x 1.3	B - see page 25
PW1028AQU023	1.92	L5-20P	Basic	15'	OU	5-20R (10)	2.1 x 24 x 1.3	B - see page 25



Part Number	Max kW	Input Plug	Function	Cord	Orientation	Receptacles	Dimensions WxHxD	Mounting Option
PW1028AQU021	1.92	L5-20P	Basic	15'	OU	5-20R (24)	2.1 x 60 x 1.3	B - see page 25



Part Number	Max kW	Input Plug	Function	Cord	Orientation	Receptacles	Dimensions WxHxD	Mounting Option
PW1038AQU032	2.88	L5-30P	Basic	10'	OU	5-20R (24)	2.1 x 60 x 1.3	B - see page 25



Part Number	Max kW	Input Plug	Function	Cord	Orientation	Receptacles	Dimensions WxHxD	Mounting Option
<a href="#">PW103BA0U038</a>	3.33	IEC60320 C20	Basic	6'	0U	IEC60320 C13 (8)	1.6 x 15.5 x 1.6	



Part Number	Max kW	Input Plug	Function	Cord	Orientation	Receptacles	Dimensions WxHxD	Mounting Option
<a href="#">PW103BA0U195</a>	3.33	L6-20P	Basic	10'	0U	IEC60320 C13 (24), IEC60320 C19 (4)	2.2 x 48 x 2.1	A - see page 25



Part Number	Max kW	Input Plug	Function	Cord	Orientation	Receptacles	Dimensions WxHxD	Mounting Option
<a href="#">PW104BA0U042</a>	3.84	L5-20P (2)	Basic	10'	0U	5-20R (2 x 12)	2.1 x 60 x 1.3	B - see page 25



Part Number	Max kW	Input Plug	Function	Cord	Orientation	Receptacles	Dimensions WxHxD	Mounting Option
<a href="#">PW105BA0U055</a>	4.99	L6-30P	Basic	10'	0U	IEC60320 C19 (4), IEC60320 C13 (24)	2.2 x 60 x 3.8	A - see page 25



Part Number	Max kW	Input Plug	Function	Cord	Orientation	Receptacles	Dimensions WxHxD	Mounting Option
<a href="#">PW314BA0U199</a>	4.99	L6-30P	Basic	10'	0U	IEC60320 C19 (4), IEC60320 C13 (24)	2.2 x 60 x 3.8	A - see page 25



Part Number	Max kW	Input Plug	Function	Cord	Orientation	Receptacles	Dimensions WxHxD	Mounting Option
<a href="#">PW306BA0U196</a>	5.76	L21-20P	Basic	10'	0U	5-20 (42)	2.2 x 72 x 2.1	A - see page 25



Part Number	Max kW	Input Plug	Function	Cord	Orientation	Receptacles	Dimensions WxHxD	Mounting Option
<a href="#">PW306BA0U197</a>	5.76	L21-20P	Basic	10'	0U	IEC60320 C13 (36), IEC60320 C19 (6)	2.2 x 70 x 2.1	A - see page 25



Part Number	Max kW	Input Plug	Function	Cord	Orientation	Receptacles	Dimensions WxHxD	Mounting Option
<a href="#">PW314BA0U198</a>	14.40	CS8365	Basic	10'	0U	IEC60320 C19 (4), IEC60320 C13 (24)	2.2 x 60 x 3.8	A - see page 25



# Basic ePDU®

## Basic ePDU® Horizontal Mount Models



Part Number	PW101BA1U140
Max kW	1.44
Input Plug	5-15P
Function	Basic
Cord	9'
Orientation	1U
Receptacles	5-15R (12)
Dimensions WxHxD	19 x 1.75 x 7
Mounting Option	D and E - see page 25



Part Number	PW103BA1U187
Max kW	3.33
Input Plug	C20 inlet
Function	Basic
Cord	Order Separately
Orientation	1U
Receptacles	IEC60320 C13 (12)
Dimensions WxHxD	19 x 1.75 x 7
Mounting Option	D and E - see page 25



Part Number	PW102BA1U184
Max kW	1.92
Input Plug	C20 inlet
Function	Basic
Cord	Order Separately
Orientation	1U
Receptacles	5-20R (12)
Dimensions WxHxD	19 x 1.75 x 7
Mounting Option	D and E - see page 25



Part Number	PW103BA1U191	PW105BA1U163	PW105BA1U192
Max kW	3.33	4.99	4.99
Input Plug	L6-20P	L6-30P	L6-30P
Function	Basic	Basic	Basic
Cord	9'	9'	9'
Orientation	1U	1U	1U
Receptacles	IEC60320 C13 (12)	IEC60320 C13 (12)	IEC60320 C13 (6), IEC60320 C19 (4)
Dimensions WxHxD	19 x 1.75 x 7	19 x 1.75 x 7	19 x 1.75 x 7
Mounting Option	D and E - see page 25	D and E - see page 25	D and E - see page 25



Part Number	PW102BA1U159	PW102BA1U158	PW103BA1U190
Max kW	1.92	1.92	2.88
Input Plug	L5-20P	5-20P	L5-30P
Function	Basic	Basic	Basic
Cord	9'	9'	9'
Orientation	1U	1U	1U
Receptacles	5-20R (12)	5-20R (12)	5-20 (12)
Dimensions WxHxD	19 x 1.75 x 7	19 x 1.75 x 7	19 x 1.75 x 7
Mounting Option	D and E - see page 25	D and E - see page 25	D and E - see page 25



Part Number	PW314BA1U193
Max kW	14.40
Input Plug	CS8365
Function	Basic
Cord	9'
Orientation	1U
Receptacles	IEC60320 C19 (6)
Dimensions WxHxD	19 x 1.75 x 7
Mounting Option	D and E - see page 25

# Metered ePDU®







## Metered ePDU®

Designed for high-density, mission critical server applications, the metered ePDU provides maximum power in a small chassis. Employing multiple configurations, the Easy-Read digital ammeter and clearly labeled circuits, the ePDU assures easy management and monitoring for current requirements and future expansion.

### Features:

- Datacenter grade receptacles ensure maximum reliability and fault-tolerance
- Easy-Read digital ammeter reduces local monitoring time
- True RMS ammeter provides accurate power measurement
- Integrated isolation mounting hardware provides maximum enclosure integrity
- Tool-less, Key-hole mounting improves installation flexibility
- Adjustable fixed mounting improves left-right and top-down space management
- Torque-controlled mechanical connections increases product fault tolerance and MTBF
- Integrated grounding bus increases product reliability

				
<b>Part Number</b>	<b>Part Number</b>	<b>Part Number</b>	<b>Part Number</b>	<b>Part Number</b>
PW102ME0U026	PW102ME0U028	PW102ME0U029	PW102ME0U030	PW103ME0U035
<b>Max kW</b>	<b>Max kW</b>	<b>Max kW</b>	<b>Max kW</b>	<b>Max kW</b>
1.92	1.92	1.92	1.92	2.88
<b>Input Plug</b>	<b>Input Plug</b>	<b>Input Plug</b>	<b>Input Plug</b>	<b>Input Plug</b>
5-20P	5-20P	L5-20P	L5-20P	L5-30P
<b>Function</b>	<b>Function</b>	<b>Function</b>	<b>Function</b>	<b>Function</b>
Metered	Metered	Metered	Metered	Metered
<b>Cord</b>	<b>Cord</b>	<b>Cord</b>	<b>Cord</b>	<b>Cord</b>
10'	10'	10'	15'	10'
<b>Orientation</b>	<b>Orientation</b>	<b>Orientation</b>	<b>Orientation</b>	<b>Orientation</b>
0U	0U	0U	0U	0U
<b>Receptacles</b>	<b>Receptacles</b>	<b>Receptacles</b>	<b>Receptacles</b>	<b>Receptacles</b>
5-20R (8)	5-20R (12)	5-20R (12)	5-20R (24)	5-20R (24)
<b>Dimensions WxHxD</b>	<b>Dimensions WxHxD</b>	<b>Dimensions WxHxD</b>	<b>Dimensions WxHxD</b>	<b>Dimensions WxHxD</b>
2.4 x 24 x 1.1	2.1 x 60 x 1.3	2.1 x 60 x 1.3	2.1 x 60 x 1.3	2.2 x 60 x 1.3
<b>Mounting Option</b>	<b>Mounting Option</b>	<b>Mounting Option</b>	<b>Mounting Option</b>	<b>Mounting Option</b>
B - see page 25	B - see page 25	B - see page 25	B - see page 25	B - see page 25

## Metered ePDU® Horizontal Mount Models

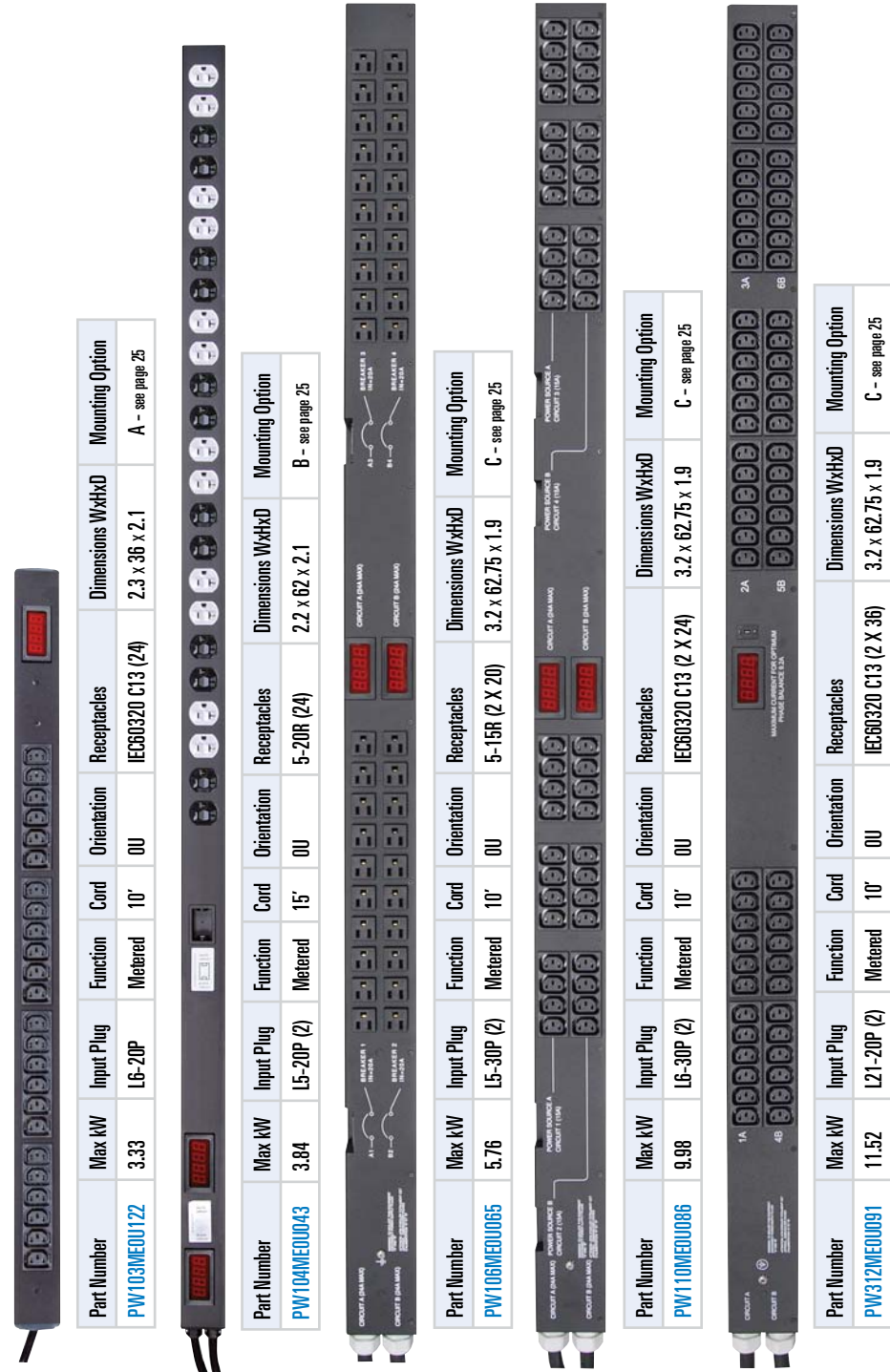

Part Number	Max kW	Input Plug	Function	Cord	Orientation	Receptacles	Dimensions WxHxD	Mounting Option
<a href="#">PW103MEU122</a>	3.33	L6-20P	Metered	10'	0U	IEC60320 C13 (24)	2.3 x 36 x 2.1	A - see page 25
<a href="#">PW104MEU043</a>	3.84	L5-20P (2)	Metered	15'	0U	5-20R (24)	2.2 x 62 x 2.1	B - see page 25
<a href="#">PW106MEU065</a>	5.76	L5-30P (2)	Metered	10'	0U	5-15R (2 X 20)	3.2 x 62.75 x 1.9	C - see page 25
<a href="#">PW110MEU086</a>	9.98	L6-30P (2)	Metered	10'	0U	IEC60320 C13 (2 X 24)	3.2 x 62.75 x 1.9	C - see page 25
<a href="#">PW312MEU091</a>	11.52	L21-20P (2)	Metered	10'	0U	IEC60320 C13 (2 X 36)	3.2 x 62.75 x 1.9	C - see page 25



Part Number	<a href="#">PW105ME1U048</a>
Max kW	4.99
Input Plug	L6-30P
Function	Metered
Cord	10'
Orientation	1U
Receptacles	IEC60320 C19 (4)
Dimensions WxHxD	19 x 1.73 x 11.8



Part Number	<a href="#">PW110ME1U083</a>
Max kW	9.98
Input Plug	IEC60309 360P6W
Function	Metered
Cord	10'
Orientation	1U
Receptacles	IEC60320 C19 (6)
Dimensions WxHxD	19 x 1.73 x 11.8

# Monitored ePDU®



## Monitored ePDU®

Designed for high-density, mission critical server applications, the monitored ePDU provides maximum power for both standard and blade servers. Employing multiple configurations, the Easy-Read digital ammeter and remote power management with clearly labeled circuits, the ePDU assures easy management and monitoring for current requirements and future expansion.

### Features:

- High-density configurations reduce enclosure space requirement
- Fuse-less design significantly reduces reset time
- UL Listed (UL489) branch circuit breakers meet UL60950-1 Edition requirements
- Easy read digital ammeter reduces local monitoring time (auto scroll capability)
- True RMS ammeter provides accurate power measurement
- Multi-purpose mounting improves installation flexibility
- Isolation hardware improves product grounding
- High-grade components increases product reliability and fault tolerance
- Clearly labeled circuits simplify load balancing





Part Number	Max kW	Input Plug	Function	Cord	Orientation	Receptacles	Dimensions WxHxD	Mounting Option
PW101M0U175	1.44	5-15P	MI	10'	OU	5-20R (24)	2.2 x 60 x 2.0	A - see page 25
PW102M0U176	1.92	5-20P	MI	10'	OU	5-20R (24)	2.2 x 60 x 2.0	A - see page 25
PW102M0U177	1.92	L5-20P	MI	10'	OU	5-20R (24)	2.2 x 60 x 2.0	A - see page 25



Part Number	Max kW	Input Plug	Function	Cord	Orientation	Receptacles	Dimensions WxHxD	Mounting Option
PW103M0U179	2.88	L5-30P	MI	10'	OU	5-20R (24)	2.2 x 68 x 2.0	A - see page 25



Part Number	Max kW	Input Plug	Function	Cord	Orientation	Receptacles	Dimensions WxHxD	Mounting Option
PW103M0U180	3.33	L6-20P	MI	10'	OU	IEC60320 C13 (24), IEC60320 C19 (4)	2.2 x 48 x 2.0	A - see page 25

	
<b>Part Number</b> PW105M10U096	<b>Part Number</b> PW105M10U098
<b>Max kW</b> 4.99	<b>Max kW</b> 4.99
<b>Input Plug</b> L6-30P	<b>Input Plug</b> L14-30P
<b>Function</b> MI	<b>Function</b> MI
<b>Cord</b> 10'	<b>Cord</b> 10'
<b>Orientation</b> 0U	<b>Orientation</b> 0U
<b>Receptacles</b> IEC60320 C13 (24), IEC60320 C19 (4)	<b>Receptacles</b> 5-20R (24)
<b>Dimensions WxHxD</b> 2.2 X 60 X 3.8	<b>Dimensions WxHxD</b> 2.2 X 64 X 3.8
<b>Mounting Option</b> A - see page 25	<b>Mounting Option</b> A - see page 25

## ePDU® Power Tip:



### Why Fuse? Circuit Breakers = Reliability

While there is little dispute that fuses can be substituted as over-current protection devices in place of more expensive, and larger circuit breakers, the purchaser of these power controllers must also consider the overall protection reliability of the system design and the total cost of ownership. Both devices will react to a current overload condition in approximately the same time (around one-half of a 60 Hz A.C. cycle) and both can be specified with comparable over-current trip limits. Also, if properly designed, both over-current protection devices will protect both local and upstream circuits. Power distribution units conforming to UL60950-1 standards must use circuit breakers or fuses rated as 'Branch Circuit Protectors' according to NEC or UL listing. The appropriate circuit breaker type is a UL489 listed unit and the appropriate fuse type is a UL248 listed JDDZ fuse classified for branch circuit protection.

- Circuit breakers, however, provide a wider variety of protection capability and are available in a greater range of trip characteristics. Using the configurability options of the electro-magnetic circuit breaker allows the designer to include additional contacts which may be used to signal the on, or off, state of the breaker, a capability not available with the fuse.
- Circuit breakers are less susceptible to temperature variations and they can also provide manual switching control
- Unlike fuses there are no replaceable elements in a circuit breaker, so there is no need to keep extras on hand.
- Circuit breakers do not show significant aging effects from repeated near over-current events while a fuse when subjected to the same environment may show a reduction in the fusible current limit.
- Increases in temperatures forming localized hot spots in an equipment rack, or data center, can result in the fuse blowing below its rated value. These hot spots do commonly occur in commercial and industrial settings. In some instances, fuses can explode under extremely high overload and when this happens, the resulting metallic vapor cloud can become a conducting path. This can result in an aberrant circuit path which could result in melted wiring or may spark a fire.
- Another important advantage of the circuit breaker is that it can be tested, and there is no way this can be done with a fuse. While you can test vast quantities of similar fuses, all this will do is provide some assurance of manufacturing quality and repeatability; it is no substitute for a test of the actual protective limiting device in the power controller.

When making the choice between these two protective elements, the user must be cognizant of these differences and the resulting total protection reliability and cost of implementation.

# Monitored ePDU®



Part Number	Max kW	Input Plug	Function	Cord	Orientation	Receptacles	Dimensions WxHxD	Mounting Option
PW105M10U099	4.99	L14-30P	MI	10'	0U	IEC60320 C13 (24), IEC60320 C19 (2), 5-20R (4)	2.2 X 64 X 3.8	A - see page 25



Part Number	Max kW	Input Plug	Function	Cord	Orientation	Receptacles	Dimensions WxHxD	Mounting Option
PW306M10U113	5.76	L21-20P	MI	10'	0U	IEC60320 C13 (24), IEC60320 C19 (3), 5-20R (6)	2.2 X 68 X 2	A - see page 25



Part Number	Max kW	Input Plug	Function	Cord	Orientation	Receptacles	Dimensions WxHxD	Mounting Option
PW306M10U185	5.76	L21-20P	MI	10'	0U	5-20R (42)	2.2 x 72 x 2.0	A - see page 25



Part Number	Max kW	Input Plug	Function	Cord	Orientation	Receptacles	Dimensions WxHxD	Mounting Option
PW306M10U181	5.76	L21-20P	MI	10'	0U	5-20R (21), I6-20R (6)	2.2 X 72 X 2.0	A - see page 25



Part Number	Max kW	Input Plug	Function	Cord	Orientation	Receptacles	Dimensions WxHxD	Mounting Option
PW306M10U182	5.76	L21-20P	MI	10'	0U	IEC60320 C13 (36), IEC60320 C19 (6)	2.2 x 70 x 2	A - see page 25



Part Number	Max kW	Input Plug	Function	Cord	Orientation	Receptacles	Dimensions WxHxD	Mounting Option
PW309M10U114	8.65	L21-30P	MI	10'	0U	IEC60320 C13 (24), IEC60320 C19 (9)	2.2 X 68 X 3.8	A - see page 25



Part Number	Max kW	Input Plug	Function	Cord	Orientation	Receptacles	Dimensions WxHxD	Mounting Option
PW309M10U115	8.65	L21-30P	MI	10'	0U	IEC60320 C13 (24), IEC60320 C19 (3), 5-20R (6)	2.2 X 68 X 3.8	A - see page 25



Part Number	Max kW	Input Plug	Function	Cord	Orientation	Receptacles	Dimensions WxHxD	Mounting Option
PW309MM0U183	8.65	L21-30P	MI	10'	OU	IEC60320 C13 (42)	2.2 x 72 x 3.8	A - see page 25



Part Number	Max kW	Input Plug	Function	Cord	Orientation	Receptacles	Dimensions WxHxD	Mounting Option
PW110MM0U189	9.98	IEC60309 360P6W	MI	10'	OU	IEC60320 C13 (12), IEC60320 C19 (12)	2.2 x 70 x 2.0	A - see page 25



Part Number	Max kW	Input Plug	Function	Cord	Orientation	Receptacles	Dimensions WxHxD	Mounting Option
PW110MM0U117	9.98	IEC60309 360P6W	MI	10'	OU	IEC60320 C13 (18), IEC60320 C19 (9)	2.2 x 70 x 3.8	A - see page 25



Part Number	Max kW	Input Plug	Function	Cord	Orientation	Receptacles	Dimensions WxHxD	Mounting Option
PW110MM0U118	9.98	IEC60309 360P6W	MI	10'	OU	IEC60320 C13 (42)	2.2 x 70 x 3.8	A - see page 25



Part Number	Max kW	Input Plug	Function	Cord	Orientation	Receptacles	Dimensions WxHxD	Mounting Option
PW314MM0U173	14.40	CS8365	MI	10'	OU	IEC60320 C13 (24), IEC60320 C19 (4), I6-30R (2)	2.2 x 70 x 2	A - see page 25



Part Number	Max kW	Input Plug	Function	Cord	Orientation	Receptacles	Dimensions WxHxD	Mounting Option
PW314MM0U174	14.40	CS8365	MI	10'	OU	IEC60320 C13 (30), IEC60320 C19 (6)	2.2 x 70 x 2	A - see page 25



Part Number	Max kW	Input Plug	Function	Cord	Orientation	Receptacles	Dimensions WxHxD	Mounting Option
PW317MM0U222	17.29	IEC60309 480P9W	MI	9'	OU	IEC60320 C13 (12), IEC60320 C19 (12)	2.2 x 66 x 3.5	F - see page 25

# Monitored ePDU®

## Monitored ePDU® Horizontal Mount Models

### Cable Restraint and Management

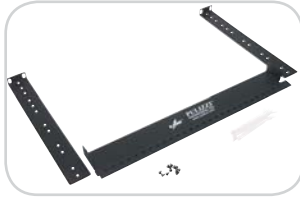

KIT-CABLRES-01

- Prevent downtime and accidental disconnection
- Secure cables/plugs to Power Distribution Unit
- Cable ties provide highest level of retention
- Black “Adjustable Bracket” versions allow front or rear mounting
  - KIT-CABLRES-01 - fits 9.5” deep units
  - KIT-CABLRES-03 - fits 7” deep units



Part Number	PW103MI1U162	PW103MI1U188
Max kW	3.33	3.33
Input Plug	L6-20P	C20 inlet
Function	MI	MI
Cord	9'	Order Separately
Orientation	1U	1U
Receptacles	IEC60320 C13 (12)	IEC60320 C13 (12)
Dimensions WxHxD	19 x 1.75 x 7	19 x 1.75 x 7
Mounting Option	D and E - see page 25	D and E - see page 25



C20 inlet  
See page 17  
for an optional  
cable restraint.



Part Number	PW101MI1U221	PW102MI1U160	PW102MI1U186
Max kW	1.44	1.92	1.92
Input Plug	5-15P	L5-20P	C20 inlet
Function	MI	MI	MI
Cord	9'	9'	Order Separately
Orientation	1U	1U	1U
Receptacles	5-15 (12)	5-20R (12)	5-20R (12)
Dimensions WxHxD	19 x 1.75 x 7	19 x 1.75 x 7	19 x 1.75 x 7
Mounting Option	D and E - see page 25	D and E - see page 25	D and E - see page 25



C20 inlet  
See page 17  
for an optional  
cable restraint.



Part Number	PW105MI1U164
Max kW	4.99
Input Plug	L6-30P
Function	MI
Cord	9'
Orientation	1U
Receptacles	IEC60320 C13 (12)
Dimensions WxHxD	19 x 1.75 x 7
Mounting Option	D and E - see page 25



Part Number	PW103MI1U161
Max kW	2.88
Input Plug	L5-30P
Function	MI
Cord	9'
Orientation	1U
Receptacles	5-20R (12)
Dimensions WxHxD	19 x 1.75 x 7
Mounting Option	D and E - see page 25



Part Number	PW105MI1U165
Max kW	4.99
Input Plug	L6-30P
Function	MI
Cord	9'
Orientation	1U
Receptacles	IEC60320 C13 (8), IEC60320 C19 (4)
Dimensions WxHxD	19 x 1.75 x 7
Mounting Option	D and E - see page 25



# Monitored ePDU®



Part Number	<a href="#">PW306MI2U166</a>
Max kW	5.76
Input Plug	L21-20P
Function	MI
Cord	9'
Orientation	2U
Receptacles	IEC60320 C13 (18), IEC60320 C19 (3)
Dimensions WxHxD	19 x 3.5 x 13.5



Part Number	<a href="#">PW110MI2U168</a>	<a href="#">PW317MI1U141</a>
Max kW	9.98	17.29
Input Plug	IEC60309 360P6W	IEC60309 460P9W
Function	MI	MI
Cord	10'	10'
Orientation	2U	2U
Receptacles	IEC60320 C19 (12)	IEC60320 C19 (12)
Dimensions WxHxD	19 x 3.5 x 9.5	19 x 3.5 x 9.5



Part Number	<a href="#">PW309MI2U167</a>
Max kW	8.65
Input Plug	L21-30P
Function	MI
Cord	9'
Orientation	2U
Receptacles	IEC60320 C13 (18), IEC60320 C19 (3)
Dimensions WxHxD	19 x 3.5 x 13.5



SUB-HRDWARE-032

## C20 Inlet Cable Restraint

- Prevent accidental disconnection of power input cable
- Connects to any standard C20 power inlet with side screws
- Cable ties provide the highest level of retention
- Flexible hole pattern accommodates any type of plug

## ePDU® Power Tip:



### Focusing On High Density Power Demands and Trends:

Today's ever changing technology has brought the need for high-density IT equipment, bringing forth the demand for more unique power solutions. The majority of data centers are looking to high-density blade servers, which can provide superior levels of performance and reliability. Not only are they more superior they take up a fraction of the space compared to the traditional servers. Blade servers were designed to pack greater processing power into a more compact area, resulting in larger quantities of data storage per square foot. As with every leap in technology usually new problems arise. One very significant problem data centers are facing with the high-density trend, is powering these dense racks of sophisticated IT equipment. Blade servers can have as many as 8 power supplies, each with C19 connections.

Focusing on the power needs of these high-density applications comes new strides in power management. Eaton's high-density ePDUs provide a way to distribute power to these mission critical devices. Traditionally a single rack of equipment would have one or two 20 amp power strips mounted in them. In more recent years it has gone to one or two 30 amp strips. The newest generations of power distribution solutions is a high-density strip that provides 50-60 amps. This approach allows an entire rack of equipment to be powered from a single power cord input. Thus reducing cabling costs and cable clutter when compared to mounting multiple power strips in an electronic enclosure. Eaton's innovative high-density ePDUs are ideal for the most power intense environments.

# V55 ePDU®



## ePDU® V55

The ePDU® V55 series high density power distribution unit integrates current and temperature monitoring into a 60 amp vertical strip. This three phase solution allows for branch circuit monitoring of up to 48 outlets over Ethernet. The configuration options include C13 or C19 outlets and various plug types. Output voltage is 208 volts to provide power supply efficiency. The outlets are connected to six branch circuit breaker sections, with load current monitoring for each section. There is a local LED amps display and the unit is Ethernet enabled for web browser or SNMP monitoring. There is integrated temperature for two locations with optional probes.

### Features:

- Detachable mounting brackets allow for several mounting options. Tool-less mounting hardware included
- Six 2 pole 20 amp circuit breakers are located on the front panel. UL 289 Listed electromagnetic circuit breakers. Meets branch circuit breaker requirements
- Breaker switch is flush with panel when “on” to prevent accidental shut off and shows red when in the off or tripped position
- Power input cable length options of 9 or 15 feet
- Power input option of terminal block input
- C13 versions have (48) IEC 60320 type C13 receptacle. Each circuit breaker protects eight receptacles
- C19 versions have (24) IEC 60320 type C19 receptacles
- C39 versions have (12) C19 and (24) C13 receptacles. Each circuit breaker protects six receptacles
- Input options of 50 or 60 amps
- Single or Three phase inputs are optional
- Ideal for blade servers or other power demanding applications



Red color indicates when the breaker is off. Circuit breaker switch is flush in the “ON” position to prevent accidental turn off.



Power input option of terminal block input

## ePDU® V55 part number guide

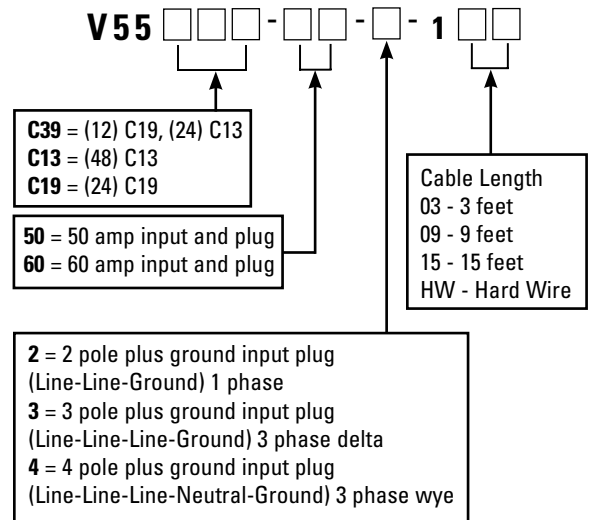

# Advanced Monitored ePDU®







## Advance Monitored ePDU®

Designed for high-density, mission critical server applications, the monitored ePDU provides maximum power for both standard and blade servers. Employing multiple configurations, the Easy-Read digital ammeter and remote power management with clearly labeled circuits, the ePDU assures easy management and monitoring for current requirements and future expansion.

### Features:

- High-density configurations reduce enclosure space requirement
- Fuse-less design significantly reduces reset time
- UL Listed (UL489) branch circuit breakers meet UL60950-1 Edition requirements
- Easy read digital ammeter reduces local monitoring time (auto scroll capability)
- True RMS ammeter provides accurate power measurement
- Multi-purpose mounting improves installation flexibility
- Isolation hardware improves product grounding
- High-grade components increases product reliability and fault tolerance
- Clearly labeled circuits simplify load balancing
- Remote individual outlet level monitoring

			
Part Number <a href="#">VPC3695-3794</a>	Part Number <a href="#">VPC3695-3792</a>	Part Number <a href="#">VPC3695-3831</a>	Part Number <a href="#">VPC3695-3832</a>
Max kW 4.99	Max kW 8.65	Max kW 9.98	Max kW 17.29
Function AM	Function AM	Function AM	Function AM
Input Plug L6-30P	Input Plug L21-30P	Input Plug IEC60309 360P6W	Input Plug IEC60309 460P9W
Cord 9'	Cord 9'	Cord 9'	Cord 9'
Orientation OU	Orientation OU	Orientation OU	Orientation OU
Receptacles IEC60320 C13 (14), IEC60320 C19 (2)	Receptacles IEC60320 C13 (21), IEC60320 C19 (3)	Receptacles IEC60320 C13 (12), IEC60320 C19 (3)	Receptacles IEC60320 C13 (12), IEC60320 C19 (3)
Dimensions WxHxD 2 X 66 X 3.5	Dimensions WxHxD 2 X 66 X 3.5	Dimensions WxHxD 2 X 66 X 3.5	Dimensions WxHxD 2 X 66 X 3.5
Mounting Option F - see page 25	Mounting Option F - see page 25	Mounting Option F - see page 25	Mounting Option F - see page 25

# Switched ePDU®

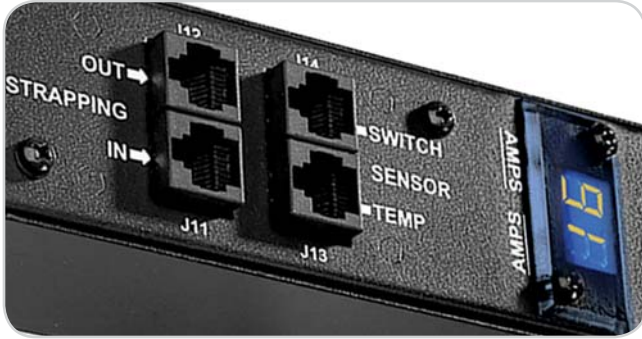





## Switched ePDU®

Designed for data centers, remote site management, the switched ePDU provides remote power monitoring of both voltage and current. The current is also displayed on a local two digit ammeter. Employing multiple configurations, available in 42" or 70" vertical lengths, providing individual on/off/reboot control of 8 to 24 AC power receptacles. The control interface is highly customizable with multiple functions flexibility, allowing setup to send either SNMP traps or e-mail alerts.

### Features:

- Intelligent Power™ Distribution
- Encrypted password protection
- IP addressable outlet control
- Control power via web browser, telnet, serial, SNMP
- 100-240 volt operation, 20-30 amp input circuit
- Up to 24 individual On/Off/Reboot outlet control
- Outlet grouping and naming
- Current and voltage monitoring
- E-mail alerts of events
- Environmental monitoring
- Highly customizable firmware interface allowing for unit naming, outlet naming, sensor naming, multiple user login/passwords, individual receptacle control, automatic scheduling outlet on/off events, DHCP, secure web server and password protection.
- Environmental monitoring provides contact closure (door/water) sensors, temperature and humidity monitoring, over/under voltage, current or outlet status changes.
- Industrial grade design made of high quality components with multiple mounting options for flexibility.

				
<b>Part Number</b>	<b>Part Number</b>	<b>Part Number</b>	<b>Part Number</b>	<b>Part Number</b>
<b>Max kW</b>	<b>Max kW</b>	<b>Max kW</b>	<b>Max kW</b>	<b>Max kW</b>
1.92	1.92	1.44	2.88	3.33
<b>Input Plug</b>	<b>Input Plug</b>	<b>Input Plug</b>	<b>Input Plug</b>	<b>Input Plug</b>
L5-20P	L5-20P	5-15P	L5-30P	L6-20P
<b>Function</b>	<b>Function</b>	<b>Function</b>	<b>Function</b>	<b>Function</b>
SW	SW	SW	SW	SW
<b>Cord</b>	<b>Cord</b>	<b>Cord</b>	<b>Cord</b>	<b>Cord</b>
9'	9'	9'	9'	10'
<b>Orientation</b>	<b>Orientation</b>	<b>Orientation</b>	<b>Orientation</b>	<b>Orientation</b>
0U	0U	0U	0U	0U
<b>Receptacles</b>	<b>Receptacles</b>	<b>Receptacles</b>	<b>Receptacles</b>	<b>Receptacles</b>
5-15R (8)	5-15R (24)	5-15R (24)	5-15R (16)	IEC60320 C13 (24)
<b>Dimensions WxHxD</b>	<b>Dimensions WxHxD</b>	<b>Dimensions WxHxD</b>	<b>Dimensions WxHxD</b>	<b>Dimensions WxHxD</b>
1.89 X 42 X 2	1.89 X 70 X 2	1.89 X 70 X 2	1.89 X 70 X 3.77	1.89 X 70 X 2
<b>Mounting Option</b>	<b>Mounting Option</b>	<b>Mounting Option</b>	<b>Mounting Option</b>	<b>Mounting Option</b>
F - see page 25	F - see page 25	F - see page 25	F - see page 25	F - see page 25



Part Number	Max kW	Input Plug	Function	Cord	Orientation	Receptacles	Dimensions WxHxD	Mounting Option
PW105SW0U154	4.99	L6-30P	SW	9'	0U	IEC60320 C13 (16)	2 X 70 X 3.77	F - see page 25



Part Number	Max kW	Input Plug	Function	Cord	Orientation	Receptacles	Dimensions WxHxD	Mounting Option
PW306SW0U155	5.76	L21-20P	SW	9'	0U	5-15R (24)	1.89 X 70 X 2	F - see page 25



Part Number	Max kW	Input Plug	Function	Cord	Orientation	Receptacles	Dimensions WxHxD	Mounting Option
PW306SW0U156	5.76	L21-20P	SW	9'	0U	IEC60320 C13 (24)	1.89 X 70 X 2	F - see page 25



Part Number	Max kW	Input Plug	Function	Cord	Orientation	Receptacles	Dimensions WxHxD	Mounting Option
PW306SW0U178	8.65	L21-30P	SW	9'	0U	IEC60320 C13 (24)	1.89 X 70 X 2	F - see page 25

## Switched ePDU® Horizontal Mount Model



Part Number	PW105SW2U223
Max kW	4.99
Input Plug	L6-30P
Function	SW
Cord	9'
Orientation	2U
Receptacles	IEC60320 C13 (20), IEC60320 C19 (4)
Dimensions WxHxD	19 x 3.5 x 9.5

## Temperature & Humidity Sensors



### Optional Sensors

#### SENSOR - T1-10

(1) Temperature Sensor, 10' Cable

#### SENSOR - T2-10

(2) Temperature Sensor, 10' Cable each

#### SENSOR - T1H1-10

(1) Temperature and Humidity Sensor, 10' Cable

#### SENSOR - T2H1-10

(1) Temperature and Humidity Sensor, 10' Cable

(1) Temperature Sensor, 10' Cable



Cable Restraint included unattached with Switched Products

# Managed ePDU®



## Managed ePDU®

Eaton's Managed ePDU combines Intelligent Power™ Distribution with breakthrough technology. Employing a server-grade microprocessor, Managed ePDUs have unprecedented management and monitoring capabilities. The result is the most comprehensive, yet easy to use, power management system available in the global marketplace.

### Features:

- Intelligent Power™ Distribution
- Comprehensive monitoring to the outlet level (Amps, Max Amps, Volts, Watts) maximizes hardware management
- 256 bit AES encryption (HTTPS, SSL, SSH, SSH2) and built in firewall provides advanced security
- Access via Serial or IP simultaneously improves connectivity in or out of band
- Easy-read digital ammeter simplifies local management (view from as far as 12' away)
- IPMI2 and Smash CLI provides harmonized user access to computer hardware and PDU
- Fuseless design provides the highest product reliability (UL489 breakers meet UL60950-1. requirements)
- User definable sequencing (outlet order and time delay) permits controlled boot-up based on equipment size
- Two tier user-definable thresholds significantly improve notification and response time
- SNMP traps and email capability simplifies and instant notification
- Onboard speaker and LED for local notification
- Field flash upgradable firmware

### Temperature & Humidity Sensors



**RS-0001**  
Single Temp  
Sensor, 9'



**RS-0002**  
Single Temp &  
Humidity Sensor, 9'



**RS-0003**  
Dual Temp &  
Humidity Sensor, 9'

Part Number	Max kW	Input Plug	Function	Cord	Orientation	Receptacles	Dimensions WxHxD	Mounting Option
<a href="#">PW1021MA0U025</a>	1.92	L5-20P	MA	10'	0U	5-15R (20)	2.2 X 71 X 2	A - see page 25
<a href="#">PW1031MA0U034</a>	2.88	L5-30P	MA	15'	0U	5-15R (20)	2.3 X 74 X 2.1	A - see page 25
<a href="#">PW1031MA0U041</a>	3.33	L6-20P	MA	15'	0U	IEC60320 C13 (20)	2.3 X 70 X 2.1	A - see page 25
<a href="#">PW1051MA0U057</a>	4.99	L6-30P	MA	10'	0U	IEC60320 C13 (12)	2.3 X 58 X 2.1	A - see page 25

# Automatic Transfer Switch ePDU®



## Automatic Transfer Switch ePDU®

Designed for switching non phase synchronized AC power sources, the automatic transfer switch ePDUs intelligent circuitry monitors both inputs, providing a fast switch ePDUs intelligent circuitry monitors both inputs, providing a fast switch transfer from primary to secondary source to power critical equipment without interruption. Status LEDs indicate power available and output source, the ePDU assures the highest level of redundancy to mission critical applications.

### Features:

- Dual power inputs automatically select a source best suited to power critical equipment.
- Ruggedized relays meet agency spacing requirements for out of phase switching up to 30 amps, while still performing fast enough to minimize transfer time.



Part Number	<a href="#">PWATSS515002</a>
Max kW	1.44
Input Plug	5-15P (2)
Function	AT
Cord	9'
Orientation	1U
Receptacles	5-15R (8)
Dimensions WxHxD	19 x 1.75 x 7
Mounting Option	D and E - see page 25



Part Number	<a href="#">PWATSS520003</a>	<a href="#">PWATSL520004</a>
Max kW	1.92	1.92
Input Plug	5-20P (2)	L5-20P (2)
Function	AT	AT
Cord	9'	9'
Orientation	1U	1U
Receptacles	5-20R (8)	5-20R (8)
Dimensions WxHxD	19 x 1.75 x 7	19 x 1.75 x 7
Mounting Option	D and E - see page 25	D and E - see page 25



Part Number	<a href="#">PWATSL530005</a>
Max kW	2.88
Input Plug	L5-30P (2)
Function	AT
Cord	9'
Orientation	1U
Receptacles	5-20R (8)
Dimensions WxHxD	19 x 1.75 x 9
Mounting Option	D and E - see page 25

# Automatic Transfer Switch ePDU®



Part Number	<b>PWATSL530007</b>
Max kW	2.88
Input Plug	L5-30P (2)
Function	AT
Cord	9'
Orientation	1U
Receptacles	L5-30R (1)
Dimensions WxHxD	19 x 1.75 x 7
Mounting Option	D and E - see page 25



Part Number	<b>PWATSL630006</b>
Max kW	4.99
Input Plug	L6-30P (2)
Function	AT
Cord	9'
Orientation	1U
Receptacles	IEC60320 C13 (12)
Dimensions WxHxD	19 x 1.75 x 9
Mounting Option	D and E - see page 25



Part Number	<b>PWATSSC20001</b>
Max kW	3.33
Input Plug	C20 Inlet (2)
Function	AT
Cord	NA
Orientation	1U
Receptacles	IEC60320 C13 (8), IEC60320 C19 (1)
Dimensions WxHxD	19 x 1.75 x 7
Mounting Option	D and E - see page 25



Part Number	<b>PWATSL630008</b>
Max kW	4.99
Input Plug	L6-30P (2)
Function	AT
Cord	9'
Orientation	1U
Receptacles	L6-30R (1)
Dimensions WxHxD	19 x 1.75 x 7
Mounting Option	D and E - see page 25

## Cable Restraint and Management

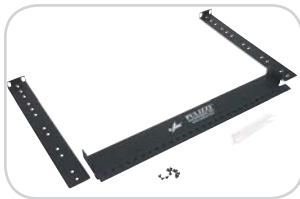

KIT-CABLRES-01

- Prevent downtime and accidental disconnection
- Secure cables/plugs to Power Distribution Unit
- Cable ties provide highest level of retention
- Black "Adjustable Bracket" versions allow front or rear mounting
  - KIT-CABLRES-01 - fits 9.5" deep units
  - KIT-CABLRES-03 - fits 7" deep units



# Rack Power Module (RPM)



## Features:

- Provides plug-and-play primary distribution of power from a three phase input source to secondary power distribution devices
- Serves data center loads with various voltages, power cord configurations and layouts
- Distributes three-phase power to 12 poles, grouped into two sets of six poles, with choice of output receptacle types
- “Power Equalizer” LED display gives quick visual indication of each circuit’s load, reducing possibility of overloads and breakers tripped off line
- Load information available from the front of the rack, no need to check individual power strips in the rear of the cabinet (hot isle)
- Branch circuit monitoring option allows easy load monitoring over the network
- Installs in only 3U of space in EIA 19” rack or enclosure (or wall mounted), all hardware included
- Enables customer installation and changes without the services of a licensed electrician

## Rack Power Module (RPM)

The RPM delivers up to 36 kW of power in an organized manner to loads of various voltages, power cords and layouts. The 3U RPM can be deployed in the same rack with the UPS and IT equipment; there’s no need for a dedicated infrastructure rack. The resulting architecture has fewer cables to manage, fewer distribution points to monitor and greater flexibility for IT personnel make changes without an electrician.

## Rack Power Module (RPM) part number guide

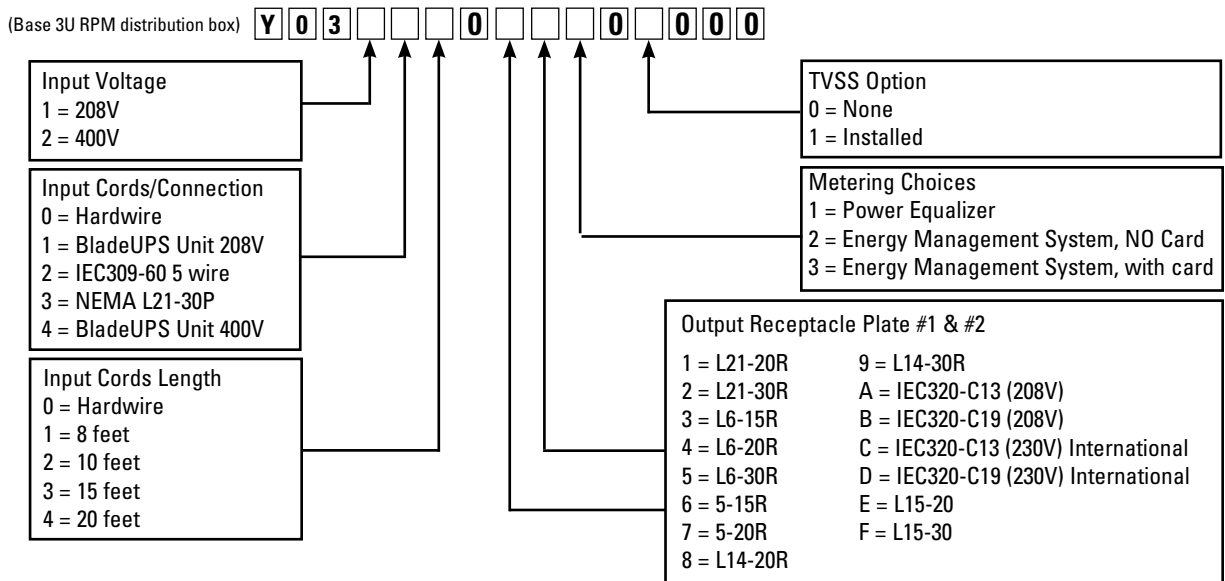

# Environmental Rack Monitor (ERM)



## Environmental Rack Monitor

### Product Snapshot

**Measure** ambient temperature and humidity at the rack level.

**Monitor** the status of up to four additional contact devices/sensors.

**Display** real-time and historical status of all sensors via the intranet or Internet.

**Stay informed** of alarms via email, PDA and pager. Act before problems affect sensitive equipment.

**Aggregate real-time information** from up to 100 Environmental Rack Monitors in a single Web page.

### Features:

- Monitors temperature and humidity at two locations in a rack and the status of up to four additional input contact sensor devices
- Protects critical assets from heat, humidity, smoke, water leaks or intrusion
- Displays real-time status to a PC, Internet-ready wireless device or Network Management System (NMS) software
- Automatically notifies designated recipients of out-of-range conditions
- Simplifies operations with an intuitive, Web browser interface, rich graphing of data, auto-discovery and auto-aggregation utilities, and more
- Five power supplies available (US/UK/Asia/Australia/IEC C13/C14)
- 1-year warranty

Yesterday's racks of equipment typically consumed less than 5 kW of power, but new blade servers can push that requirement to more than 20 kW per rack. The heat given off by these high-intensity servers is expected to double in the next 10 years. Even as IT environments are getting hotter,

racks and equipment rooms are more tightly packed than ever, leaving less open space for air circulation. The result is unbalanced airflow and undesirable hot spots in and around sensitive equipment. It has been found that heat-related issues are to blame for 60 percent of hardware downtime. Other environmental threats-such as humidity, water leaks, smoke and cabinet intrusion-can be equally harmful to mission critical data equipment if the rack environment isn't supervised locally.



OU device with its own web server

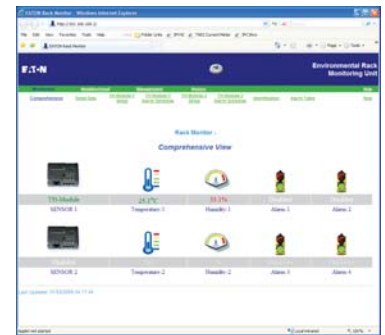

Main view of single Environmental Rack Monitor.



Control Center



Temperature/Humidity Sensor



Smoke Detector



Vibration Sensor



Door Security Detector



Water Leak Detector

Part Number	Description
103005775	Environmental Rack Monitor, with Temperature/Humidity Sensor and Power Supply (120V)
103005912	Environmental Rack Monitor, with Temperature/Humidity Sensor and Power Supply (208V)
103005780	Water Leak Detector, 3 ft.
103005894	Water Leak Detector 12 ft.
103005781	Door Contact Sensor
103005782	Vibration Sensor
103005822	Temperature/Humidity Sensor
103005890	Smoke Detector/Alarm (120V)

# Enterprise Power Manager (EPM)

## Enterprise Power Manager

EPM provides low cost network management of power distribution and UPS through one interface. This software is compatible with all ePDUs that have Ethernet connection including - Monitored, Advanced Monitored, Switched and Managed products.

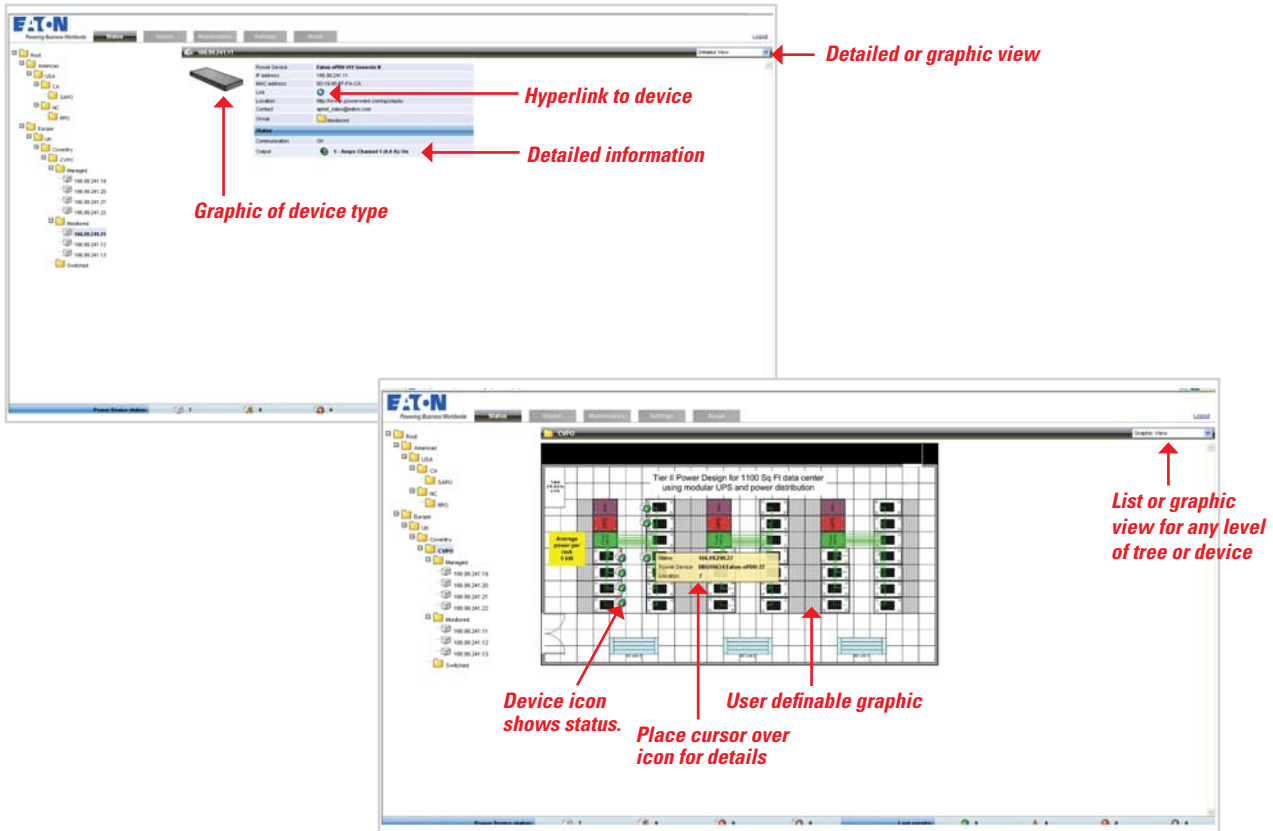









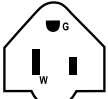
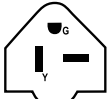

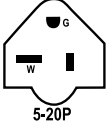

## EPM Features and Benefits

EPM Key Feature	Benefit
User definable tree structure	- Enables grouping, access and management of multiple devices over multiple locations
User definable graphics view	- Single interface to view all alerts. Minimize response time, reduce time to repair, maximize uptime. Alerts via mobile phones & e-mail.
Aggregation of device alarms	- Single interface to view all alerts. Minimize response time, reduce time to repair, maximize uptime. Alerts via mobile phones & e-mail.
Aggregated device views	Grouping of multiple 'like' devices simplifies management. Single interface accessible from anywhere on the network through a web browser
Device firmware management	- Reduce set-up and maintenance time of devices by mass-upgrading firmware (not currently functional with ePDU, only UPS)
Shutdown agent management	- Enables safe shutdown of servers
Device maintenance schedules	- Schedule and track maintenance, moves, adds and changes of equipment in the data center
Device types	- SNMP devices are visible and their individual web interfaces accessible for editing /configuration.
ePDU	
UPS (<10kVA)	
Security	- Application is secure and allows remote access via password etc
Multi-platform	- Linux, Windows and Mac OSX – it doesn't matter which operating system is in use
Browser Based	- IE 6 and 7, Firefox and Safari. The system can be installed locally, or on a main server and browsed to.
Auto Discovery	- Fast installation - automatically detect devices on your network.
Remote Monitoring	- Interface is web-based which enables remote monitoring and access to systems

# ePDU® Plugs and Receptacles



## Standard NEMA Plugs

 <p>5-15 120V 15A 1 phase straight blade</p> <p>5-15P</p>	 <p>6-20 208V 20A 1 phase straight blade</p> <p>6-20P</p>	 <p>L21-20 120/208V 20A, 3 phase wye</p> <p>L21-20P</p>	 <p>L22-20 277/480V 20A 3 phase wye</p> <p>L22-20P</p>
 <p>5-20 120V 20A 1 phase straight blade</p> <p>5-20P</p>	 <p>L6-20 208V 20A 1 phase twist lock</p> <p>L6-20P</p>	 <p>L21-30 120/208V 30A 3 phase wye</p> <p>L21-30P</p>	 <p>L22-30 277/480V 30A 3 phase wye</p> <p>L22-30P</p>
 <p>L5-20 120V 20A 1 phase twist lock</p> <p>L5-20P</p>	 <p>L6-30 208V 30A, 1 phase</p> <p>L6-30P</p>	 <p>L15-20 208V 20A 3 phase delta</p> <p>L15-20P</p>	
 <p>L5-30 120V 30A 1 phase twist lock</p> <p>L5-30P</p>	 <p>L14-30 120/240V 30A 2 phase (split phase)</p> <p>L14-30P</p>	 <p>L15-30 208V 30A 3 phase delta</p> <p>L15-30P</p>	





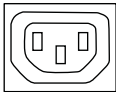

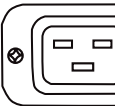
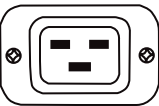
### THE IEC ADVANTAGE:



The IEC 60320 and IEC 60309 connectors described below are the most commonly specified. The IEC connector system is used throughout the world. By utilizing a Eaton® ePDU® Power Distribution System with the IEC connectors, you can attach the correct cable assembly for British, Australian, Continental European, North American and many other cable/connector configurations. This allows you to purchase and inventory one ePDU for shipment anywhere in the world.

### IEC 60320

 <p>C13</p>	 <p>C14</p>	 <p>C19</p>	 <p>C20</p>
North American	15 amp	250 volts	20 amp
Europe	10 amp	250 volts	16 amp
			250 volts

### IEC 60309

30 amp	60 amp	30 amp	60 amp	60 amp	60 amp
 <p>2P3W 250V</p>	 <p>2P3W 250V</p>	 <p>4P5W 3ØY230/400V</p>	 <p>3P4W 3Ø250V</p>	 <p>4P5W 3ØY120/208V</p>	 <p>4P5W 3ØY230/400V</p>

50 amp, 2P3W 250V	 <p>HBLCS8265C</p>
50 amp, 3P4W 3Ø250V	 <p>HBLCS8365C</p>

# Power Cables and Accessories

By turning to Eaton, you and your customers can enjoy one-stop shopping for a full range of power quality and power distribution needs, including power cables. The Eaton cable portfolio includes nearly two dozen choices in three product categories:

- **Adapters** to enable equipment with disparate input/output receptacles to work together
- **Jumpers** to connect two pieces of equipment without cluttering up the cable arrangement
- **Splitters** to add extra equipment to a UPS or PDU without using up more outlets

All Eaton power cables are tested and certified for use with Eaton products, such as enclosure PDUs (ePDUs), rack power modules (RPMs) and UPSs—proven to deliver the reliability and service life needed for the most rigorous data center applications

- Choose from adapters, jumpers and splitters for any rack power distribution application
- Select from a broad range of input/output connectors
- Streamline cabling in enclosures by deploying exactly the cable length needed
- Count on assured performance with pre-tested products that meet UL and Eaton standards

## Adapter Cables



**010-0032:**  
C14 to NEMA 5-15R  
125V, 15A  
1 foot, 16AWG/3wire



**010-9334:**  
C19 to NEMA 5-15P  
125V, 15A Straight Blade  
8 foot, 14AWG/3wire



**010-9335:**  
C19 to NEMA 5-20P  
125V, 20A Straight Blade  
8 foot, 12AWG/3wire



**010-9336:**  
C19 to NEMA 6-15P  
250V, 15A Straight Blade  
8 foot, 14AWG/3wire



**010-9337:**  
C19 to NEMA 6-20P  
250V, 20A Straight Blade  
8 foot, 12AWG/3wire



**010-9338:**  
C19 to NEMA L5-15P  
125V, 15A Twist-Lock  
8 foot, 14AWG/3wire



**010-9339:**  
C19 to NEMA L5-20P  
125V, 20A Twist-Lock  
8 foot, 12AWG/3wire



**010-9340:**  
C19 to NEMA L6-15P  
250V, 15A Twist-Lock  
8 foot, 14AWG/3wire



**010-9341:**  
C19 to NEMA L6-20P  
250V, 20A Twist-Lock  
8 foot, 12AWG/3wire



**010-0034:**  
8 foot, 12AWG/3wire  
C19 to Bare Wire  
(Pig Tail)



**010-9342:**  
C20 Male to C19  
20 AMP  
8 foot, 12AWG/3wire



**010-0025:** 8 foot  
**010-0027:** 6 foot  
**010-0028:** 4 foot  
**010-0029:** 2 foot  
C13 to C14 Harmonized,  
1mm/3wire, 100-240V rated

## Jumper Cables

## Outlet Caps



**035-0113:**  
C13 Outlet Cap



**035-0119:**  
C19 Outlet Cap

## Splitter Cables



**CBL139 Splitter Cable**  
L14-30R to (2) L6-30R (4 ft/2 ft)



**CBL143 Splitter Cable**  
L14-30R to (2) L5-30R (4 ft/2 ft)



**CBL148 Splitter Cable**  
L14-20R to (2) L5-20R (4 ft/2 ft)



**CBL149 Splitter Cable**  
L21-30R to (3) L5-30R (4 ft/2 ft/1 ft)



**CBL150 Splitter Cable**  
L21-20R to (3) L5-20R (4 ft/2 ft/1 ft)

# Mounting Options

## Mounting Option A

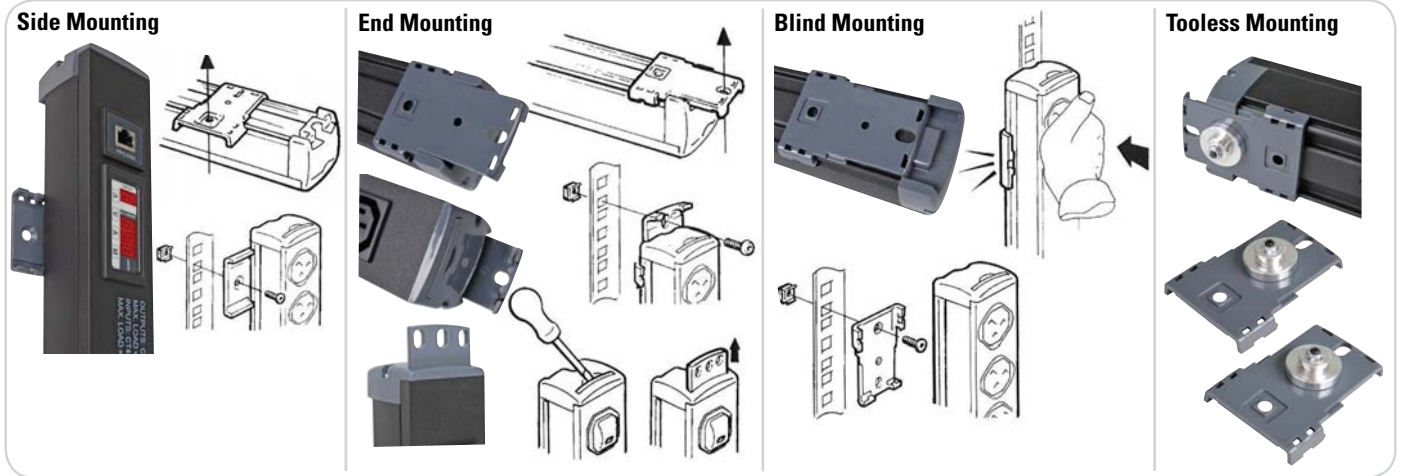

## Mounting Option B



## Mounting Option C



## Mounting Option D and E

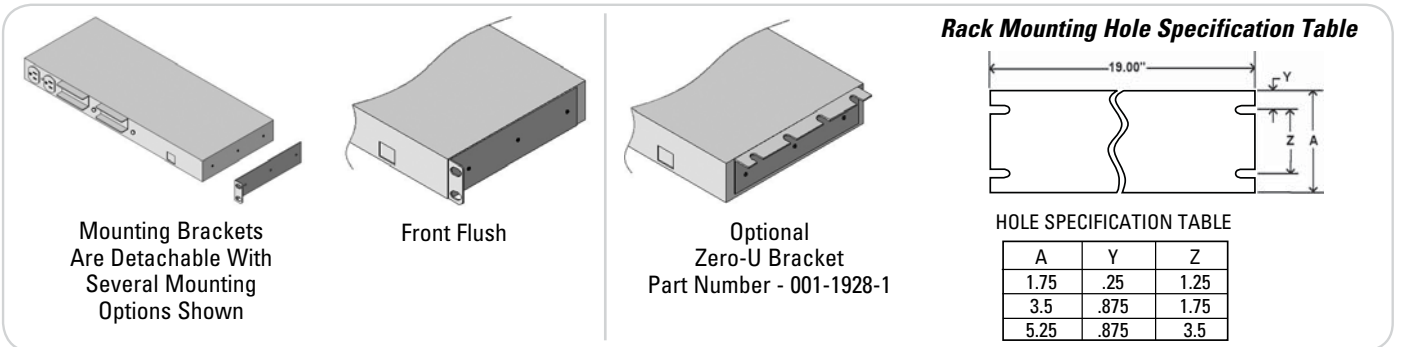

## Mounting Option F



# ePDU.com Product Configurator



## ePDU.com is Making Product Configuration as Easy as 1, 2, 3...

ePDU is helping make the selection of enclosure power distribution units, as easy as 1, 2, 3. This product configuration wizard is a simple interface that allows the customer to search over 1,000 products for the perfect solution. This site allows the customer to ask themselves three very key questions about their power needs.

1. How much power do you need?
2. What functionality do you need?
3. What inputs and outputs do you need?

Making the right decisions from the start can make a difference in the dependability and efficiency of an infrastructure.

This innovative site allows the customer to explore features, benefits and learn basic fundamentals of ePDUs, as well as allows them to demo live interface.

Eaton's ePDUs offer a broad range of functionalities including basic, metered, monitored, advanced monitored, switched, managed and automatic transfer switch products. This website will allow the customer to go through the different options available for their needs, and find the product right for them. If they need help or have questions with their selection they can use the Live Chat icon, or call one of the listed support numbers.

Eaton offers the largest selection of enclosure based power distribution units available on the market. With today's changing technology and the data centers 99.99% demand for reliability, IT professionals not only need sophisticated equipment to measure power consumption, they also need a sophisticated product search tool to help them find the appropriate solution.

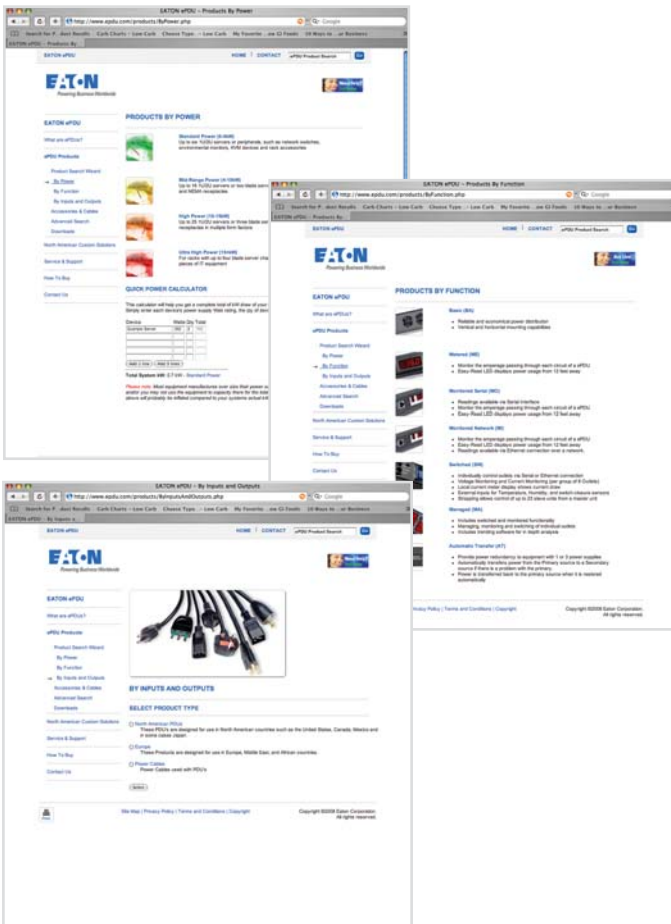

## Sign-Up for Data Center Forum

The Data Center Forum is a quarterly newsletter for IT professionals that provides new insight for managing IT infrastructures. Visit ePDU.com and sign-up to start receiving your issues!

UNITED STATES  
8609 Six Forks Road  
Raleigh, NC 27615 U.S.A.  
Toll Free: 1.800.356.5794

[www.epdu.com](http://www.epdu.com)

CANADA  
Ontario: 416.798.0112  
Toll Free: 1.800.461.9166

LATIN AMERICA  
Argentina: 54.11.4343.6323  
Brazil: 55.11.3616.8500  
Mexico: 52.55.9000.5252  
Portugal: 55.11.3616.8500

EUROPE/MIDDLE EAST/AFRICA  
Denmark: 45.3686.7910  
Finland: 358.94.52.661  
France: 33.1.6012.7400  
Germany: 49.0.7841.604.0  
Italy: 39.02.66.04.05.40  
Norway: 47.23.03.65.50  
Sweden: 46.8.598.940.00  
United Kingdom: 44.1753.608.700



PowerChain  
Management®

ASIA PACIFIC  
Australia: 61.2.9693.9366  
New Zealand: 64.0.3.343.3314  
China: 86.21.6361.5599  
HK/Korea/Taiwan: 852.2745.6682  
India: 91.11.2649.9414 to 18  
Singapore/SEA: 65.6825.1668

Eaton, Powerware, PowerChain Management and ePDU are trade names, trademarks, and/or service marks of Eaton Corporation or its subsidiaries and affiliates.

© 2009 Eaton Corporation  
All Rights Reserved  
Printed in USA  
March 2009



*Powering Business Worldwide*